

NOUVEAU

INNOVATION



NOUVEAU

TETRABAC THERM INSIDE

Lanterneau remplissage verre sur embase polyester isolée

tolplex

NOUVEAU : TETRABAC THERM INSIDE

Lanterneau remplissage verre sur embase polyester

Tetrabac Therm Inside est le premier appareil pour toitures sèches avec remplissage verre (disponible en double et triple vitrage)

Du verre sur toitures sèches !

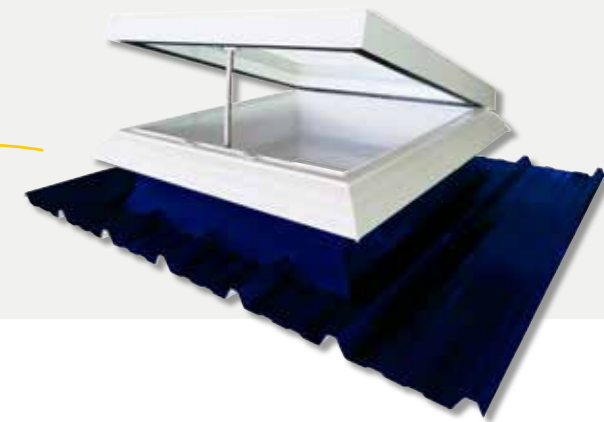

Caractéristiques

- Embase polyester armée fibres de verre parois extérieures protégées par le gel coat hauteur 300 mm isolée 19 mm
- Existe en Fix et Air élec (course 300 mm)
- RAL extérieur possible
- 6 dimensions commerciales disponibles :

Dim com	Dim lum	DROITE		
		DR	B1	B2
80 / 80	80 x 80	•	-	-
110 / 110	100 x 100	-	•	-
120 / 120	100 x 100	-	-	•
150 / 150	130 x 130	-	-	•
80 x 110	70 x 100	-	•	-
120 / 150	100 x 130	-	-	•

■ disponible / - non disponible

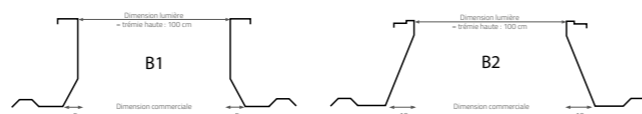

Coupe Tetrabac Therm Inside fixe (trémie droite)

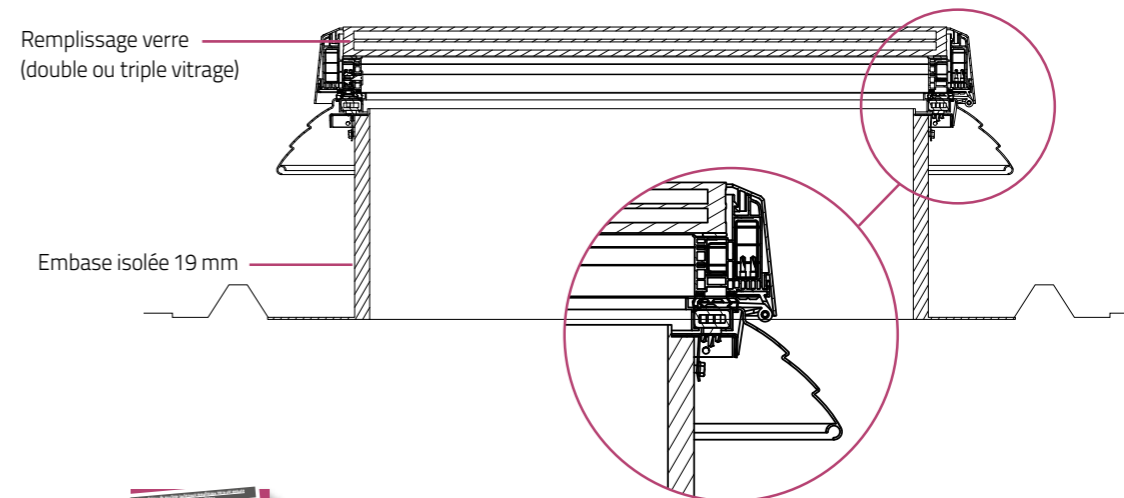

Notice fournie

Avantages

- + Esthétique : Vision du ciel
- Confort acoustique
- Réduit la consommation d'énergie dans le bâtiment grâce à l'apport de lumière naturelle
- Confort thermique

Urc = 1,4 W/m².K
Arc = 3,7 m²

(pour un Tetrabac Therm Inside Fix, dim com 120 x 150 B2, Ht 300 mm, triple vitrage)

Produits disponibles

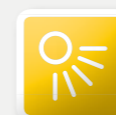

ÉCLAIREMENT ZENITHAL



Tetrabac Therm Inside Fix



AÉRATION

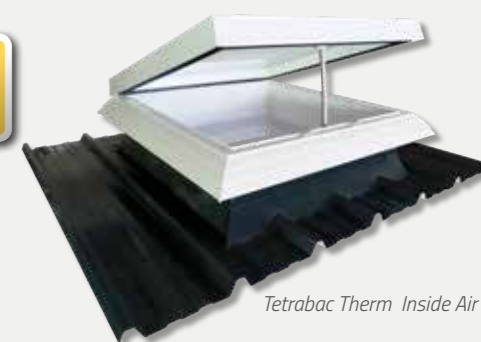

Tetrabac Therm Inside Air élec

EXISTE AUSSI : *Gamme Tetrabac Therm*

TETRABAC THERM



ÉCLAIREMENT
ZENITHAL



AÉRATION



ACCÈS TOITURE



DÉSENFUMAGE



BSL
BRISE SOLEIL LUMINEUX®

Urc de 1,4 W/m².K à 2,2 W/m².K



PEARL
INSIDE®

Urc de 1,7 W/m².K à 2,8 W/m².K



EXISTE AUSSI : *Gamme Inside*

KARAT INSIDE



ÉCLAIREMENT
ZENITHAL



AÉRATION

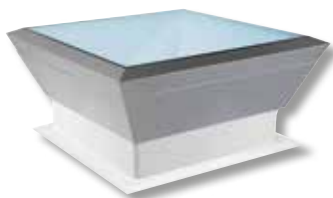

Urc : 0,7 W/m².K
Rw = 30 (-1;-3) dB

PHONI INSIDE



ÉCLAIREMENT
ZENITHAL



AÉRATION



ACCÈS TOITURE



DÉSENFUMAGE

Urc : 1,1 W/m².K
Rw = 37 (0;-1) dB

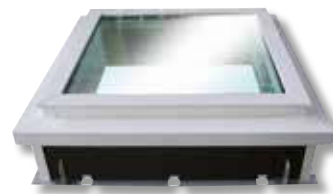

SLICK INSIDE ROND OU CARRÉ



ÉCLAIREMENT
ZENITHAL



AÉRATION



Urc : 1,1 W/m².K
Rw = 29 (-1;-3) dB

STEEL INSIDE



ÉCLAIREMENT
ZENITHAL



AÉRATION



ACCÈS TOITURE



DÉSENFUMAGE

Urc : 1,2 W/m².K
Rw = 34 (-1;-2) dB

